

Service Data Sheet

Issue 9 - 12.2012

This document is protected by copyright and may not, in whole or part be stored in a retrieval system, or transmitted in any form or by any means, copied, photocopied, translated or reduced to any machine-readable form without prior consent in writing from Triumph Motorcycles Limited.

No liability can be accepted for any inaccuracies or omissions in this publication, although every possible care has been taken to make it as complete and accurate as possible.

Triumph Motorcycles Limited reserves the right to make changes and alter specifications without prior notice and without incurring an obligation to make such changes to products manufactured previously. See your authorised Triumph dealer for the latest information on product improvements incorporated after this publication.

All information contained in this publication is based on the latest product information available at the time of publication. Illustrations in this publication are intended for reference use only and may not depict actual model component parts.

© Triumph Motorcycles Ltd. 2012

SERVICE DATA SHEET

Speed Triple from VIN 461332/Speed Triple R

Brakes

- Brake disc maximum run out 0.3 mm (front) 0.15 mm (rear)
- Brake disc minimum thickness 4.0 mm (front) 5.0 mm (rear)
- Brake fluid DOT 4

Master Cylinders

Front brakes from VIN 461332

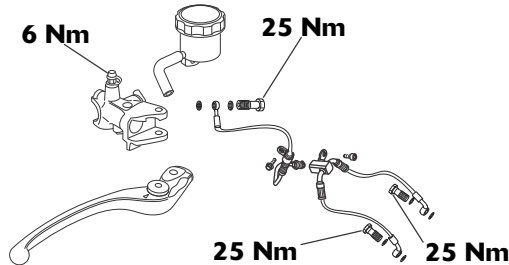

Rear brakes from VIN 461332

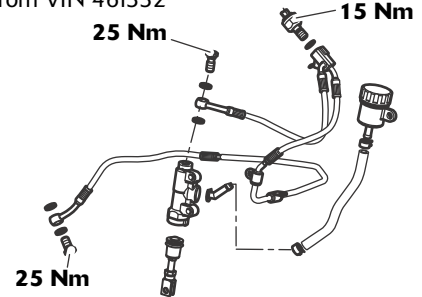

Calipers and Brake Pads

Front brakes from VIN 461332

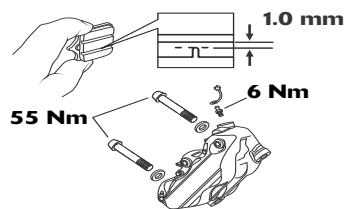

Rear brakes from VIN 461332

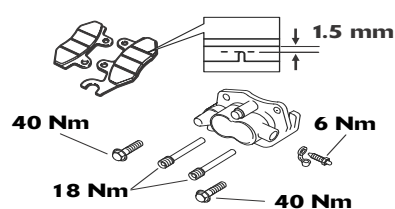

Engine and Lubrication

- Oil Semi or fully synthetic 10W/40 or 10W/50 engine oil which meets specification API SH (or higher) and JASO MA. Triumph recommends Castrol Power 1 Racing 4T 10W/40 or 10W/50 (fully synthetic) engine oil, sold as Castrol Power RS Racing 4T 10W/40 or 10W/50 (fully synthetic) in some countries
- Fill quantity 3.2 litres (oil and filter change). Always refer to the dipstick/filler plug markings for correct level
- Grease To NLGI 2 specification
- Coolant type Triumph HD4X Hybrid OAT coolant (premixed as supplied by Triumph)
- Coolant capacity 2.4 litres
- Camshaft cover bolt Lubricate the seals for the camshaft cover bolts with clean engine oil
- Camshaft cover tightening sequence Tighten the camshaft cover bolts in the sequence shown below. Bolts 1 and 4 are torqued twice, the second time as 7 and 8

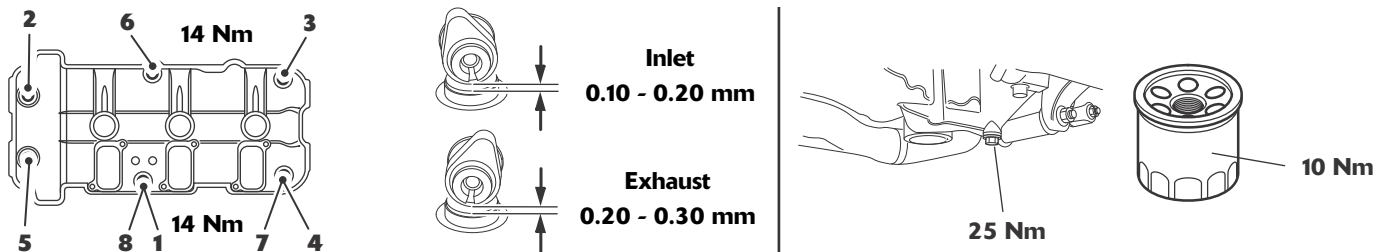

Fuel and Air

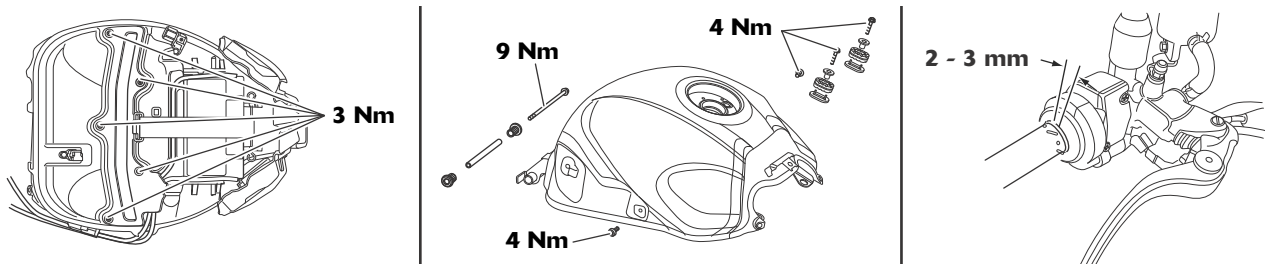

SERVICE DATA SHEET - continued

Final Drive and Clutch

Chain lubrication..... Chain spray suitable for O-ring chains

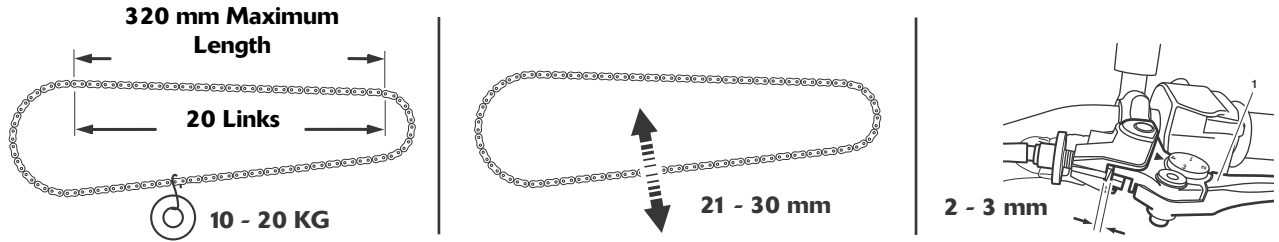

Battery and Ignition

Charge rate Must not exceed 1.2A (refer to the service manual)

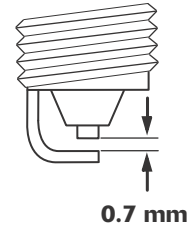
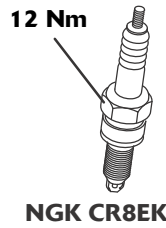
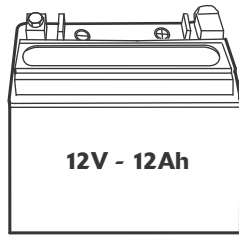

Suspension and Wheels

Recommended fork oil grade Showa SS8 (SAE 10W) (Speed Triple), Öhlins fork oil (Speed Triple R)

Oil volume (dry fill) 552 cc (Speed Triple), 478 cc (Speed Triple R)

Oil level (fork fully compressed) 85 mm (Speed Triple), 130 mm (Speed Triple R)

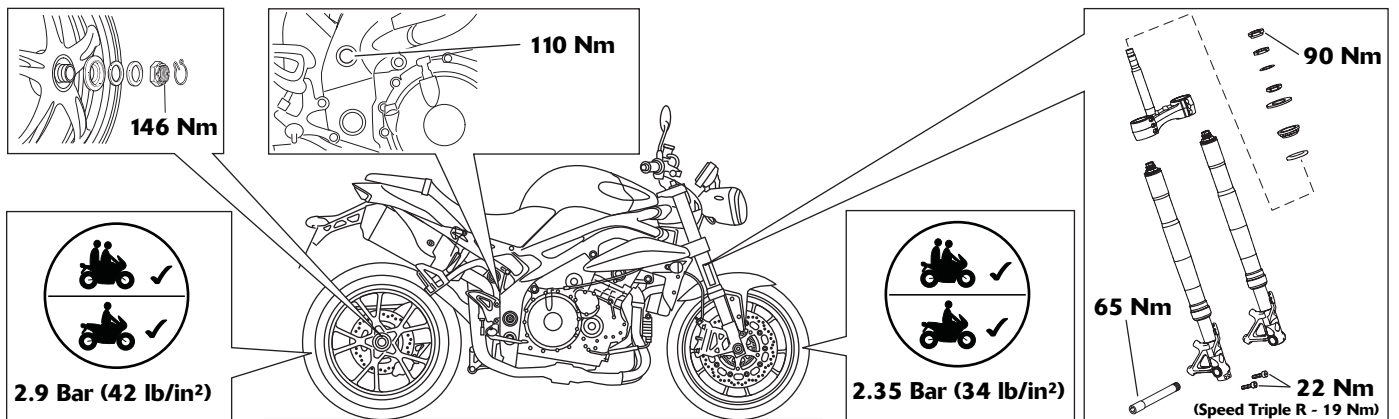

Service Parts Information

Part Number	Description	Odometer Reading in Miles (kms), Time Period				
		500/ 1 month (800) Annual	6,000 (10,000)	12,000 (20,000)	18,000 (30,000)	24,000 (40,000)
T3550605	Sump Plug Washer	•	•	•	•	•
T1210444	Oil Filter	•	•	•	•	•
T2206602	Air Cleaner			•		•
T1290181	Spark Plug			•		•
T1261337	Camshaft Cover Seal			•		•
T1260309	Camshaft Cover Bolts Seal			•		•
T2025247	Front Brake Pad Set	As Necessary				
T2020555	Rear Brake Pad Set	As Necessary				