

Service Data Sheet

Issue 9 - 12.2012

This document is protected by copyright and may not, in whole or part be stored in a retrieval system, or transmitted in any form or by any means, copied, photocopied, translated or reduced to any machine-readable form without prior consent in writing from Triumph Motorcycles Limited.

No liability can be accepted for any inaccuracies or omissions in this publication, although every possible care has been taken to make it as complete and accurate as possible.

Triumph Motorcycles Limited reserves the right to make changes and alter specifications without prior notice and without incurring an obligation to make such changes to products manufactured previously. See your authorised Triumph dealer for the latest information on product improvements incorporated after this publication.

All information contained in this publication is based on the latest product information available at the time of publication. Illustrations in this publication are intended for reference use only and may not depict actual model component parts.

© Triumph Motorcycles Ltd. 2012

SERVICE DATA SHEET

Thunderbird/Thunderbird Storm

Brakes

Brake disc maximum run out. Front 0.25 mm - Rear 0.25 mm
 Brake disc minimum thickness. Front 4.5 mm - Rear 5.5 mm
 Brake fluid. DOT 4

Master Cylinders

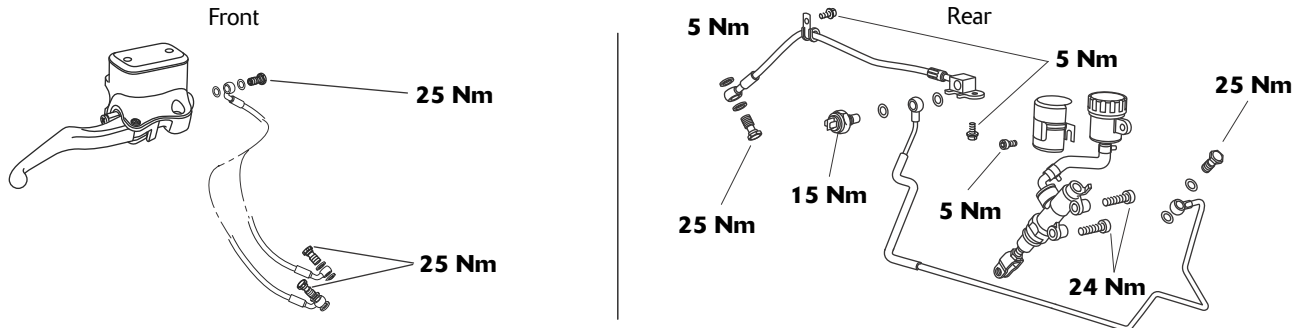

Calipers and Brake Pads

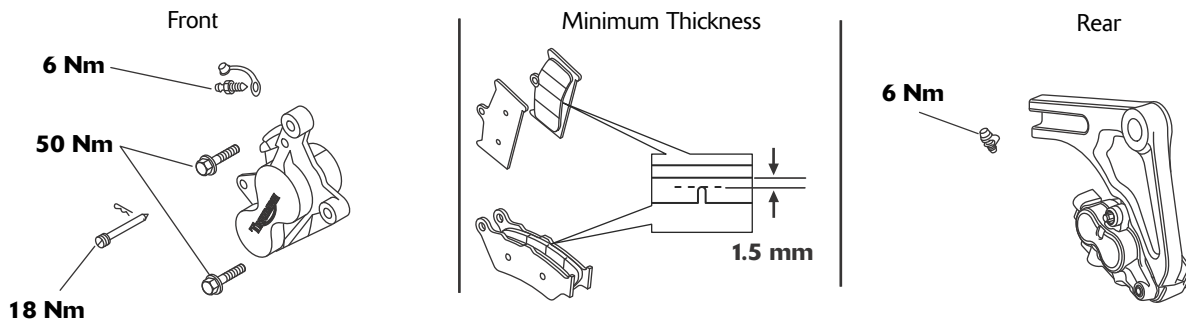

Engine and Lubrication

Oil. Semi or fully synthetic 10W/40 or 10W/50 engine oil which meets specification API SH (or higher) and JASO MA. Triumph recommends Castrol Power 1 Racing 4T 10W/40 or 10W/50 (fully synthetic) engine oil, sold as Castrol Power RS Racing 4T 10W/40 or 10W/50 (fully synthetic) in some countries
 Fill quantity 4.2 litres (oil and filter change). Always refer to dipstick/filler cap markings for correct oil level
 Coolant type Triumph HD4X Hybrid OAT coolant (premixed as supplied by Triumph)
 Coolant capacity 2.2 litres
 Grease. Grease to NLGI 2 specification
 Camshaft cover bolts Lubricate the seals for the camshaft cover bolts with clean engine oil
 Camshaft cover tightening sequence. Tighten the camshaft cover bolts in the sequence shown below

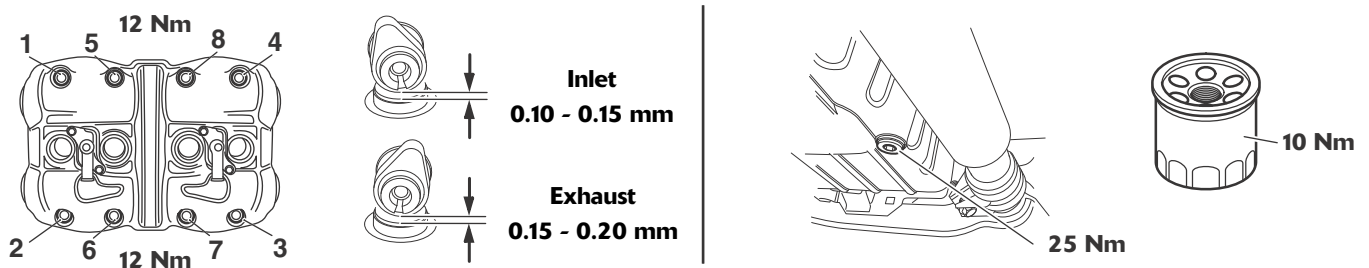

Fuel and Air

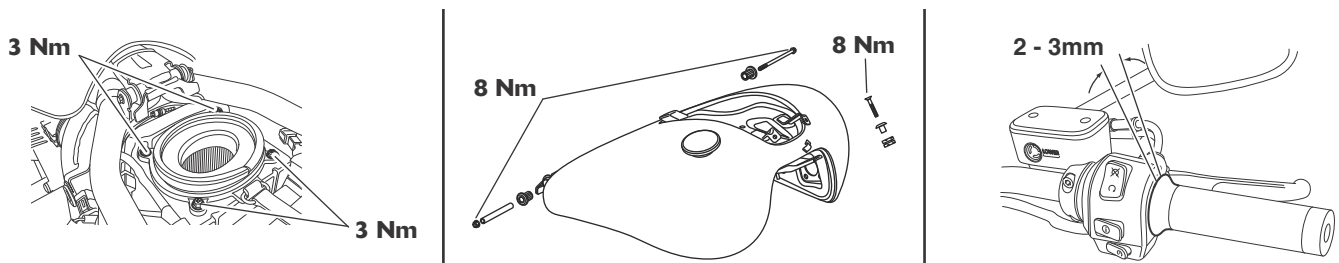

SERVICE DATA SHEET - continued

Final Drive Belt and Clutch

Final drive belt adjustment To adjust the drive belt, refer to the service manual

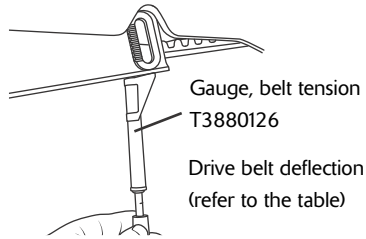
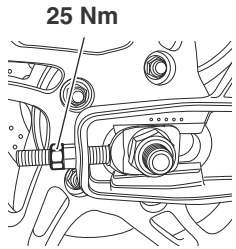

Motorcycle on sidestand	5.5 to 7.0 mm (0.20 to 0.27 in)
Motorcycle on Support stand T3880803	7.5 to 9.0 mm (0.30 to 0.35 in)

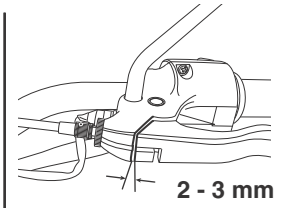

Battery and Ignition

Charge rate Must not exceed 1.8A (refer to the service manual)

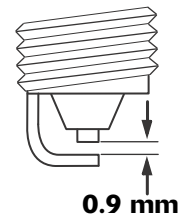
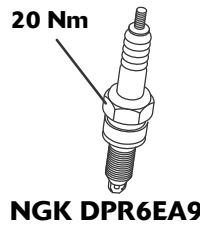
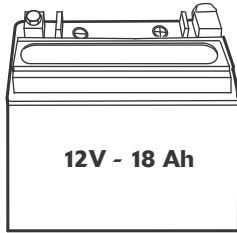

Suspension and Wheels

Recommended fork oil grade Showa AHSS8 (SAE 10W)

Oil volume (dry fill) 677 cc

Oil level (fork fully compressed) 106 mm

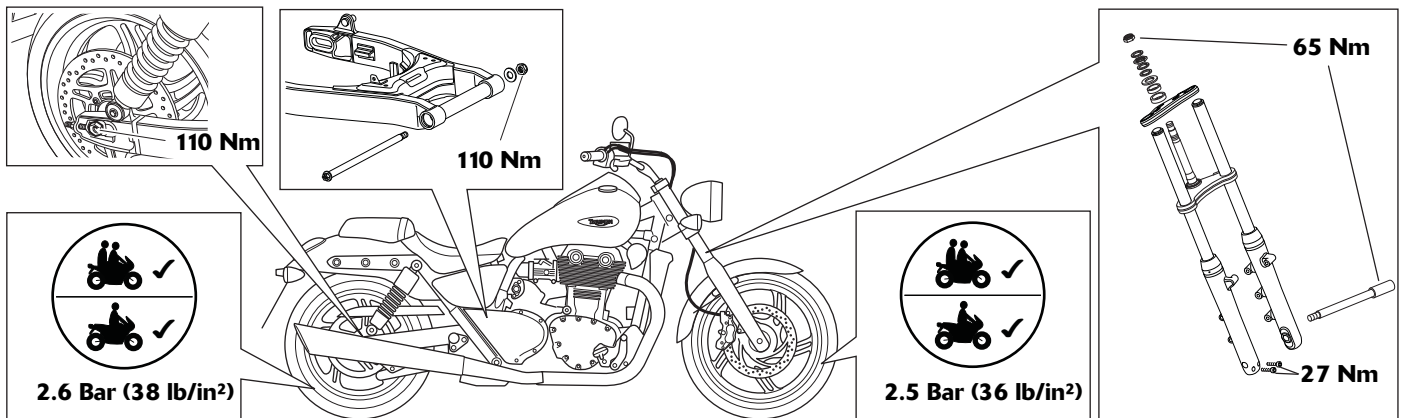

Service Parts Information

Part Number	Description	Odometer Reading in Miles (kms), Time Period				
		500/ 1 month (800) Annual	6,000 (10,000)	12,000 (20,000)	18,000 (30,000)	24,000 (40,000)
T3550605	Sump Plug Washer	As Necessary				
T1210444	Oil Filter	•	•	•	•	•
T2202450	Air Filter			•		•
T1296999	Spark Plug (two per cylinder)			•		•
T1240850	Fuel Filter			•		•
T1260246	Camshaft Cover Seal			•		•
T1260309	Camshaft Cover Bolt Seal			•		•
T2020393	Front Brake Pad Set	As Necessary				
T2020848	Rear Brake Pad Set	As Necessary				
T2010461	Drive Flange Assembly					•